







This grate is part of ACO's Heelsafe® Anti-Slip range. For more information visit www.heelsafe.com.au

Product Features

-  Certified to AS 3996 Load Class G (900kN) (NATA endorsed load test reports available)
 -  AS 3996 (Clause 3.3.6 compliant for surface openings in pedestrian areas ASME A112.6.3 (Section 7.12) compliant - American high heel standard)
 -  AS 4586: P3 – Slip resistance classification for Wet Pendulum Test
AS 4586: R10/R10¹ - Slip resistance classification for Oil-Wet Inclining Platform Test
 -  AS 1428.1 (Clause 4.4c) compliant for wheelchair and walking cane safety
 -  AS 3996 (Clause 3.3.7) compliant for bicycle tyre penetration resistance
 - Recesses in grate fit around 'anti-shunt' lugs on the edge rail to prevent longitudinal movement
 - **PowerLok** barless and boltless locking system
 - Suitable for use with S100K, H100SK channels
 - Manufactured from ductile iron to AS 1831 Grade 500-7
- ¹. Test direction (perpendicular/parallel) relative to the grate's length (NATA endorsed test reports available)



Specifications

The grate shall be ACO S100K/H100SK* Iron Intercept **Heelsafe® Anti-Slip** grate with **PowerLok** barless and boltless locking system as manufactured by ACO. This grate has an overall width of 138mm and overall length of 500mm. Slot widths measure at a maximum of 6mm.

Materials & Design

The grate shall be manufactured from ductile iron and have **minimum** properties and characteristics as follows:

- Recesses in grate fit around 'anti-shunt' lugs on the edge rail to prevent longitudinal movement
- Manufactured from ductile iron to ASTM AS 1831 Grade 500-7
- Certified to AS 3996 Load Class G (900kN)²
- AS 4586: P3 – Slip resistance classification for Wet Pendulum Test²
- AS 4586: R10/R10¹ – Slip resistance classification for Oil-Wet Inclining Platform Test²
- Meets AS 1428.1 (Clause 4.4c); AS 3996 (Clause 3.3.6 & 3.3.7); ASME A112.6.3 (Section 7.12)
- Intake area of 9,800mm² per half metre of grate

¹ Test direction (perpendicular/parallel) relative to the grate's length

² NATA endorsed test reports available

For the specification of the ACO Drain channel system selected, click: <http://www.acodrain.com.au/product-support>

*delete as appropriate

ACO Specification Information



ACO DRAIN®

S100K/H100SK Iron Intercept Heelsafe® Anti-Slip grate

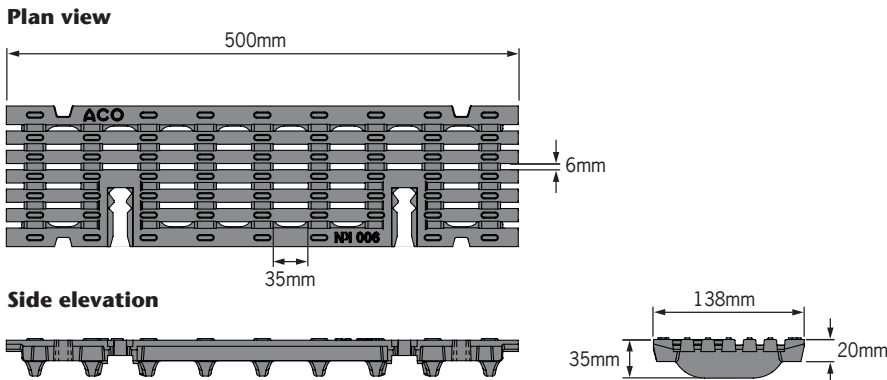

| Description | Part No. | Length (mm) | Width (mm) | Weight (kg) |
|---|---------------|-------------|------------|-------------|
| PowerLok grate | | | | |
| S100K/H100SK Iron Intercept Heelsafe® Anti-Slip | 141299 | 500 | 138 | 6.8 |
| Grate removal tool | 01318 | - | - | 0.1 |
| PowerLok safety clip | 10443 | - | - | - |

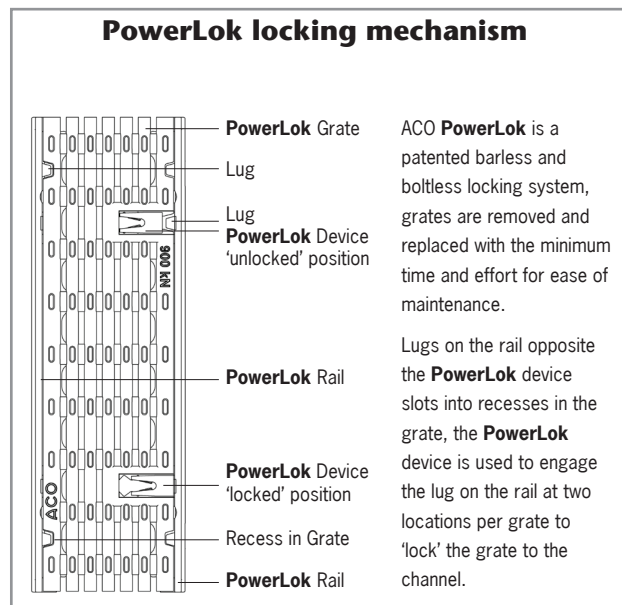

ACO Pty Ltd
Australia
Ph: 1300 765 226
www.acodrain.com.au
sales@acoaus.com.au

ACO Limited
New Zealand
Ph: 0800 448 080
www.acodrain.co.nz
sales@aconz.co.nz



© January 2022 ACO Pty Ltd. All reasonable care has been taken in compiling the information in this document. All recommendations and suggestions on the use of ACO products are made without guarantee since the conditions of use are beyond the control of the company. It is the customer's responsibility to ensure that each product is fit for its intended purpose and that the actual conditions are suitable. ACO Pty Ltd. pursues a policy of continuous product development and reserves the right to amend specifications without notice.